

## ADM 322: Rotary actuator

### How energy efficiency is improved

Best operating convenience, precision activation and high energy efficiency with minimal operating noise.

### Features

- For operating control units such as control valves, butterfly valves etc.
- For controllers with a switching output (2-point or 3-point control)
- 15 Nm nominal torque and holding torque
- Synchronous motor with electronic control unit and load-dependent cut-off
- Low operating noise
- Direction of operation and running time can be set using coding switches
- Gear unit can be disengaged for manual adjustment
- Electrical parallel operation of up to five actuators possible
- Numerous adapters enable the unit to be fitted onto defined non-SAUTER control valves
- Maintenance-free gearbox made of plastic and steel, and gearbox base-plates made of steel
- Mounting columns made of aluminium

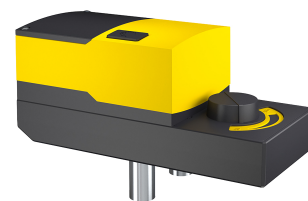

ADM322F12\*



### Technical data

| Power supply               |                                      |   |
|----------------------------|--------------------------------------|---|
|                            | Power supply 24 V~                   | ± 20%, 50...60 Hz   |
|                            | Power supply 24 V=                   | -10%...20%  |
|                            | Power supply 230 V~                  | ± 15%   |
|                            | Connections (screw terminals)        | Max. 1.5 mm <sup>2</sup>  |
| ADM322(H, P)F120           | Power consumption                    | < 2.2 W   |
| ADM322(H, P)F122           | Power consumption                    | < 2.5 W   |
| Parameters                 |                                      |   |
|                            | Operating noise <sup>1)</sup>        | < 30 dB(A) (loaded)   |
|                            | Running time for 90°                 | 120 (240) s   |
|                            | Response time                        | < 200 ms  |
|                            | Angle of rotation                    | Max. 95°  |
|                            | Rotational torque and holding torque | 15 Nm   |
| Ambient conditions         |                                      |   |
|                            | Operating temperature                | -20...55 °C   |
|                            | Storage and transport temperature    | -40...80 °C   |
|                            | Humidity without condensation        | 5...85% rh  |
| Construction               |                                      |   |
|                            | Dimensions W x H x D                 | 194 × 116 × 86 mm   |
|                            | Weight                               | 1.5   |
|                            | Fitting position                     | Vertically upright to horizontal, not fitted upside down          |
|                            | Housing                              | Three-part  |
|                            | Housing material                     | Flame retardant yellow/black plastic                              |
|                            | Cable inlet                          | With break-outs, for metric screw fittings M20×1.5                |
| Standards and directives   |                                      |   |
|                            | Type of protection                   | IP54 (EN 60529)   |
|                            | Protection class                     | II (EN 60730-1), EN 60730-2-14<br>III (EN 60730-1), EN 60730-2-14 |
| CE conformity according to | EMC Directive 2014/30/EU             | EN 61000-6-1<br>EN 61000-6-2<br>EN 61000-6-3<br>EN 61000-6-4      |
|                            | Low-Voltage Directive 2014/35/EU     | EN 60730-1<br>EN 60730-2-14                                       |

<sup>1)</sup> Operating noise with the slowest running time



|  |              |
|--|--------------|
| Over-voltage categories  | III          |
| Degree of contamination  | II           |
| Max. altitude  | 2000 metres  |
| Machinery Directive 2006/42/EC<br>(according to Appendix II, 1B) | EN ISO 12100 |

#### Overview of types

| Type        | Nominal voltage | Type               |
|-------------|-----------------|--------------------|
| ADM322F120  | 230 V~          | –                  |
| ADM322F122  | 24 V~/=         | –                  |
| ADM322HF120 | 230 V~          | Auxiliary contacts |
| ADM322HF122 | 24 V~/=         | Auxiliary contacts |
| ADM322PF120 | 230 V~          | Potentiometer      |
| ADM322PF122 | 24 V~/=         | Potentiometer      |

#### Accessories

| Type       | Description   |
|------------|---|
| 0510600001 | Cable module, 1.2 m, 3-wire, PVC                            |
| 0510600002 | Cable module, 1.2 m, 3-wire, halogen-free                   |
| 0510600003 | Cable module, 1.2 m, 6-wire, PVC                            |
| 0510600004 | Cable module, 1.2 m, 6-wire, halogen-free                   |
| 0510600005 | Cable module, 5 m, 3-wire, PVC                              |
| 0510600006 | Cable module, 5 m, 3-wire, halogen-free                     |
| 0510600007 | Cable module, 5 m, 6-wire, PVC                              |
| 0510600008 | Cable module, 5 m, 6-wire, halogen-free                     |
| 0510240013 | ADM322 mounting kit with M3R, M4R, MH32, MH42               |
| 0510240014 | ADM322 fitting kit with DEF DN20...65                       |
| 0510240015 | ADM322 fitting kit with DEF DN80...100                      |
| 0510390002 | Adapter set for control valve, Honeywell, DZ/ZR valves only |
| 0510390003 | Adapter set for control valve, Danfoss                      |
| 0510390004 | Adapter set for control valve, Caleffi                      |
| 0510390005 | Adapter set for control valve, Coster                       |

#### Description of operation

This actuator is used to operate control units like control valves, butterfly valves etc. in HVAC installations and must only be used for these purposes.

The actuator can be used as a 2-point (OPEN/CLOSE) or 3-point actuator (OPEN/STOP/CLOSE).

The running time of the actuator can be set with the S1 switches according to the respective requirements.

The direction of rotation can be changed using switch S2.

In the end positions (control or butterfly valve limit stop or when the maximum angle of rotation is reached) or upon overload, the load-dependent cut-off responds before the electronic control unit turns off the motor.

The manual adjustment is performed by releasing the gear unit (button on top of housing) and simultaneously adjusting the spindle adapter. This enables the manual positional setting. The gear unit is automatically coupled in when the button is released.

#### Intended use

This product is only suitable for the purpose intended by the manufacturer, as described in the "Description of operation" section.

All related product regulations must also be adhered to. Changing or converting the product is not admissible.

#### Connection as 2-point actuator (24 V or 230 V)

The OPEN/CLOSE activation is via two wires.

The actuator is connected to a permanent voltage via terminals MM or N and 01. The rotary actuator is moved to the end position by connecting the voltage to terminal 02 (clockwise direction to 0% angle of rotation, with the direction of rotation as seen from the actuator to the spindle adapter). After the voltage is switched off at terminal 02, the actuator automatically retracts into the base position (anti-clockwise direction to 100% angle of rotation).

### Connection as 3-point actuator (24 V or 230 V)

If voltage is applied to terminals MM or N and 01 (or 02), the control valve can be moved to any desired position.

If voltage is applied to terminals MM or N and 01, the actuator rotates in the anti-clockwise direction (direction of rotation as seen from the actuator to the spindle adapter). If the electrical circuit is closed on terminal MM and 02, the damper actuator rotates in the clockwise direction. If there is no voltage on terminals 01 and 02, the actuator remains in the respective position until voltage is applied again.

#### Note



ADM 322 with 230 V

A load wired in parallel to terminal 2 can falsify the result of the direction detection of the actuator.

The following parameters must be maintained for correct direction detection:

- Only ohmic loads are admissible.
- At U = 230 V, the load's resistance must be greater than 20 kΩ.
- At U = 264 V (230 V +15%) the load's resistance must be greater than 30 kΩ.

### Connection with auxiliary contacts

ADM322HF120 and ADM322HF122 have two integrated auxiliary switches S1 and S2.

Two rotary knobs on the cover enable auxiliary switches S1 and S2 to be adjusted to any position from the 90° angle of rotation.

Auxiliary switch S1 is connected via terminals 11 and 12 (normally-closed contacts) or via terminals 11 and 13 (normally-open contacts).

Auxiliary switch S2 is connected via terminals 14 and 15 (normally-closed contacts) or via terminals 14 and 16 (normally-open contacts).

### Connection with potentiometer

ADM322PF120 and ADM322PF122 have an integrated potentiometer. The supply to the potentiometer must be applied between terminals 12 and 13 in the range from 1...10 V.

### Coding switch

#### ADM322F120/SF122/HF/PF

de Schalterkodierung  
fr Codage de commutation  
en Switch coding  
it Codifica di intervento  
es Codificación de conmutación  
sv Kodomkopplare  
nl Schakelcodering

de Stellzeit  
fr Temps de positionnement  
en positioning time  
it tempo di manovra  
es tiempo de ajuste  
sv ställtid  
nl steltijd

de Wirksinn  
fr Sens d'action  
en Direction of operation  
it Direzione dell'azione  
es Sentido de mando  
sv Driftriktning  
nl Werkingsrichting

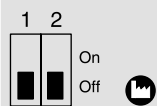

120 s



240 s

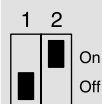

### Engineering and fitting notes

The concept of synchronous motor/electronics ensures electrical parallel operation of up to five rotary actuators of the same type.

The housing has two break-out cable inlets for metric screw fittings made of plastic M20 × 1.5. When the screw fittings are being screwed in, these cable inlets are broken out automatically.

The cross-section of the power cable must be selected based on the cable length and the number of actuators. With five actuators wired in parallel and a cable length of 50 m, we recommend a cable cross-section of 1.5 mm<sup>2</sup> (power consumption of the actuator × 5). According to building installation regulations, the lines must be protected from overload or short circuit.

The rotary actuator is fitted on the control valve or the butterfly valve using the adapter (see accessory list).

The coding switches are accessible via an opening in the connection area of the actuator. Before the conversion, the equipment must be disconnected from the electricity supply.

Actuators with a potentiometer:

It is not admissible to measure the position using a resistance input.



#### WARNING!

Electric shock!

► Always ensure that the device is disconnected from the mains before removing the plastic cover for the connection area.

The actuators are not suitable for use in potentially explosive environments, on ships, in vehicles, in plants or in machinery where functional safety is required.

Specific standards such as IEC/EN 61508, IEC/EN 61511, EN ISO 13849 and the like have not been taken into account.

Local requirements regarding installation, usage, access, access rights, accident prevention, safety, dismantling and disposal must be taken into account.



#### NOTICE!

Damage to property!

► Do not open the housing as otherwise the product will be damaged.

### Outdoor installation

In case of installation outside buildings, the devices must also be protected from the weather.

### Additional information

|  |            |
|--|------------|
| Document                                     |            |
| Fitting instructions                         | P100012579 |
| Declaration on materials and the environment | MD 51.332  |

### Disposal

When disposing of the product, observe the currently applicable local laws.

More information on materials can be found in the Declaration on materials and the environment for this product.

### Power consumption at nominal voltage

| Type                | Running time for 90° (s) | State       | Active power P (W) | Apparent power S (VA) |
|---------------------|--------------------------|-------------|--------------------|-----------------------|
| ADM322F120          | 120/(240)                | Operation   | < 2.2              | < 4.0                 |
| as well as HF/PF120 |                          | Standstill* | < 0.3              |                       |
|                     |                          | Sizing      | > 2.5              | 4.0                   |
| ADM322F122          | 120/(240)                | Operation   | < 2.5              | < 4.0                 |
| as well as HF/PF122 |                          | Standstill* | < 0.3              |                       |
|                     |                          | Sizing      | ≥ 3.0              | ≥ 4.0                 |

\*) Standstill = actuator in the end position, voltage applied to terminal 1 or 2, motor switched off

**Dimension drawing**

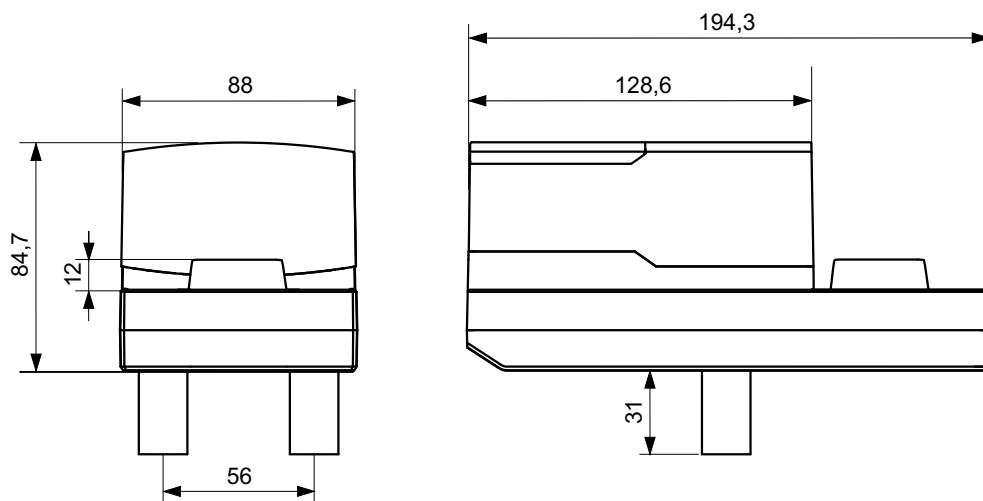

**Connection diagram**

ADM322F120  
 ADM322F122  
 ADM322HF120  
 ADM322HF122  
 ADM322PF120  
 ADM322PF122

**2pt/3pt Multi-position action**

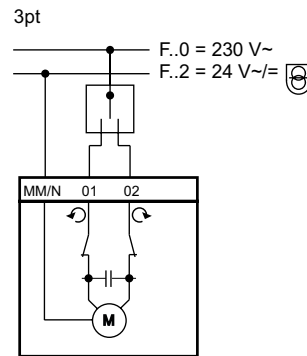
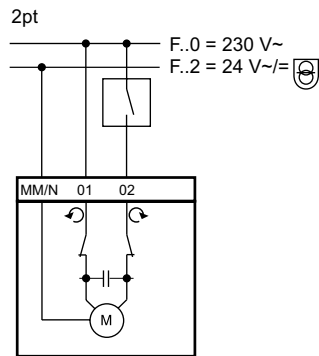

ADM322HF120  
 ADM322HF122

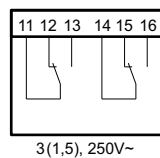

ADM322PF120  
 ADM322PF122

